

APTA Peer Reviews

A Perspective from the North
(Calgary, Alberta, Canada)

Presenter: Karim Rayani

Organization: Calgary Transit

Title: Manager, Access Calgary

Why do an APTA Peer Review?

✓ Wide Network





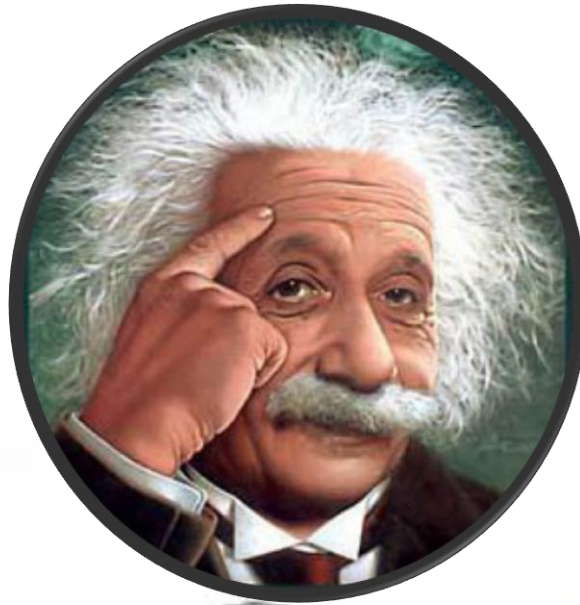

Why do an APTA Peer Review?

✓ Experience



Why an APTA Peer Review?

✓ Easy to Coordinate

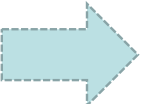
- ❖ Purpose:  Issue  Validation  Best Practices
- ❖ Expectations  No Disappointments
- ❖ Selection of Peers  Request Peers from Similar Properties

Why do an APTA Peer Review?

✓ Cost

- ❖ Reasonable
- ❖ Value
- ❖ ROI



Why do an APTA Peer Review?

✓ Credibility

- ❖ Unbiased Reporting
- ❖ APTA recognized by stakeholders
- ❖ No Personal Gain



Why do an APTA Peer Review?

- ✓ List of APTA Peer Reviews conducted at Calgary Transit
 - ❖ Access Calgary Driver Training
 - ❖ Calgary Transit Operator and Maintenance Training
 - ❖ Calgary Transit Rail Audit
 - ❖ Access Calgary Operations Review
 - ❖ Calgary Transit Safety Audit
 - ❖ Public Safety and Enforcement Training Program

Why do an APTA Peer Review?

✓ Access Calgary Driver Training

❖ **Issues:**



Contractor
Trainers
Not Consistent
in Delivery

Why do an APTA Peer Review?

✓ Access Calgary Driver Training

❖ **Issues:**



Training
Materials

Why do an APTA Peer Review?

✓ Access Calgary Driver Training

❖ **Issues:**



Customer
Complaints
Service
Consistency

Why do an APTA Peer Review?

✓ Access Calgary

❖ **Issues:**

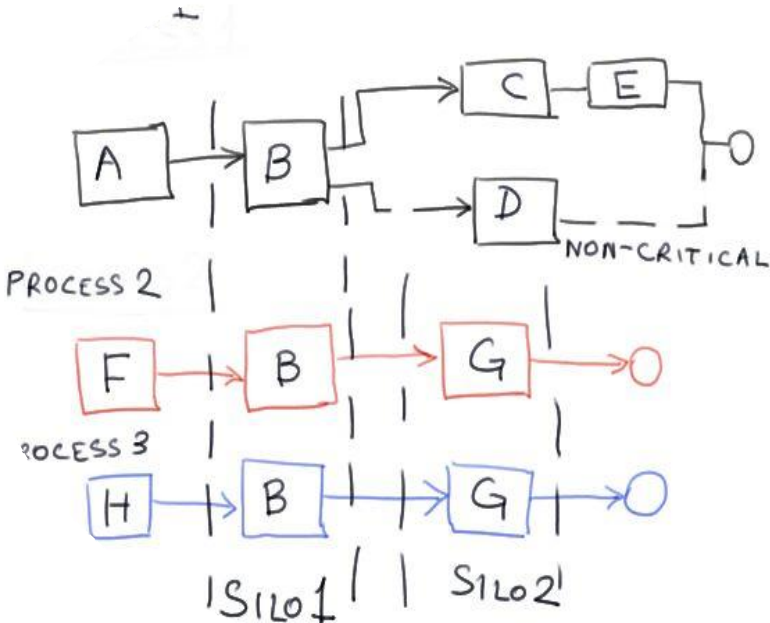

Policies and Procedures

Why do an APTA Peer Review?

✓ Access Calgary Driver Training

❖ **Action:**

- Initiated request to APTA for a Peer Review of Access Calgary's Service Contractors' Driver Training Programs
- Reviewed concerns with APTA staff
- Confirmed expectations and desired outcomes for Peer Review
- APTA selected four Peer properties similar in operation

Why do an APTA Peer Review?

✓ Access Calgary Driver Training

❖ Action: On-Site

- **APTA Peer Review Team reconfirmed scope and expectations**

- **Meetings held with:**
 - Customers
 - Access Calgary Advisory Committee
 - Service Contractors
 - Access Calgary staff



Why do an APTA Peer Review?

✓ Access Calgary Driver Training

❖ Action: On-Site

➤ APTA Peer Review Team members:

- Conducted Ride-Alongs with each Contractor Access Calgary
- Visited a couple Contractor facilities

➤ Reviewed all Training Materials and Service Contracts

Why do an APTA Peer Review?

✓ Access Calgary Driver Training

❖ Action: On-Site

➤ **APTA Peer Review Team made the following Recommendations:**

APTA TEAM RECOMMENDATIONS

- ✓ Access Calgary Driver Training
- ❖ **Be more prescriptive in contracts around training content**
- ❖ **Set minimum duration of training provided by the contractors,**
- ❖ **Lead a joint initiative with contractors to standardized training curriculum.**
- ❖ **Develop a train- the-trainer in-house that all contractors must attend**
- ❖ **Audit the training provided by contractors on a regular basis**
- ❖ **Formalize Access Calgary policies and procedures**
- ❖ **Consequences for non-compliance.**

Why do an APTA Peer Review?

✓ Access Calgary Driver Training

❖ Results

- Buy-in from all Contractors to jointly create new Driver Training Program led by Access Calgary staff.
- Train the trainer program being developed for contractors
- Service Contracts have been tightened up and much more prescriptive
- New Policy and Procedures manual being developed for Access Calgary

KEY ACHIEVEMENT: Better Trained Drivers and Consistent Service for CUSTOMERS

Why do an APTA Peer Review?

✓ Final Thoughts

- ❖ Transit Agency – Due Diligence
- ❖ APTA Peer Reviews can be a Catalyst for Change
- ❖ Recommendations from the APTA Peer Review Team can position Transit Agency to make the case for more Resources
- ❖ Satisfied Funding Partners - Efficient and Effective Service Delivery



Calgary Transit



THE CITY OF
CALGARY

LEAVE BLANK

